

断面配筋図

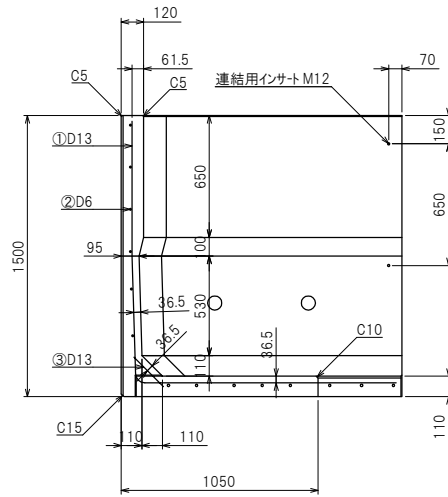

たて壁配筋図

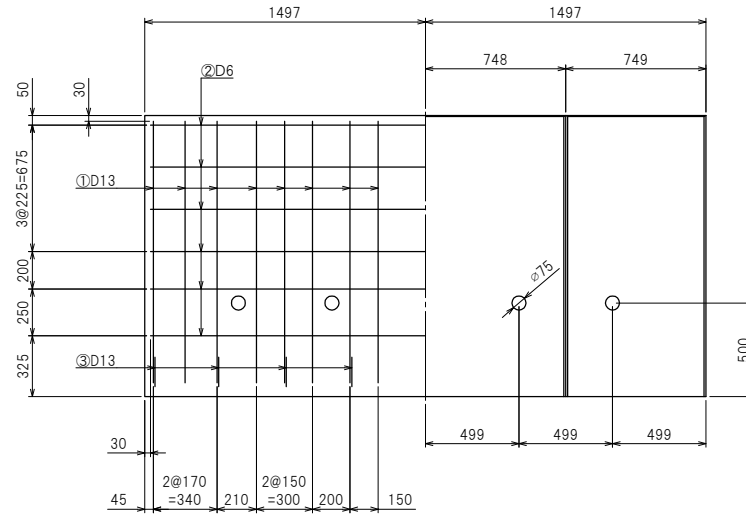

鉄筋加工図

①D13 L=2347~2779 n=16

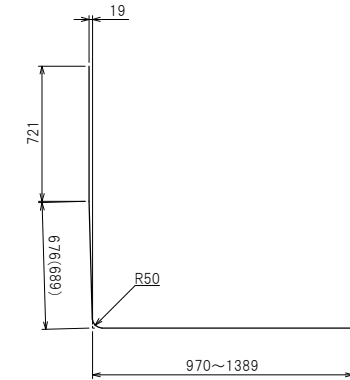

②D6 L=1415 n=12

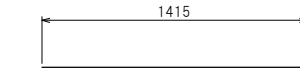

③D13 L=222 n=8



コーナー部補強筋
D6 L=400 n=6

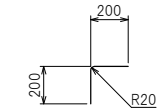

底板先端部補強筋
D13 L=654 n=1

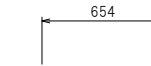

平面構造図

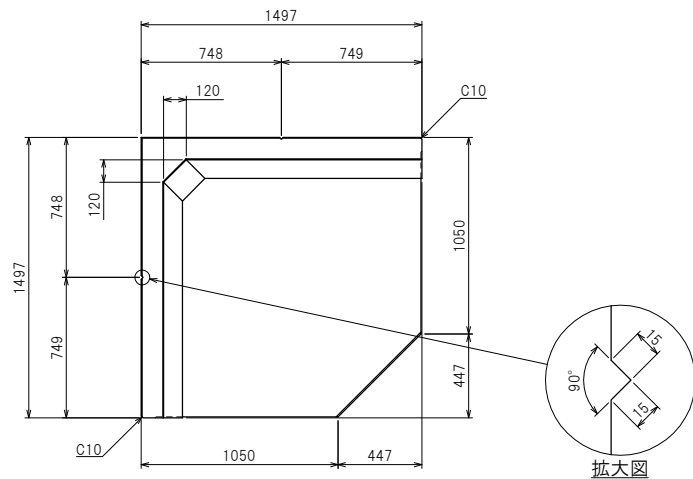

底板配筋図

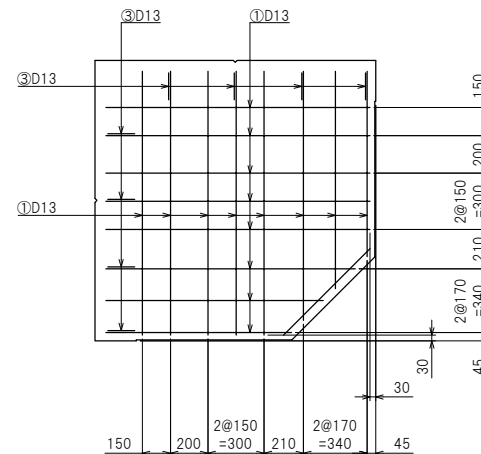

図面作成日: 30. 2.14

製品名	KCウォールⅡ型(90° コーナー)
サイズ	H=1500
参考重量	1793 kg
栗本建材株式会社 クリモコンクリート	