

断面配筋図

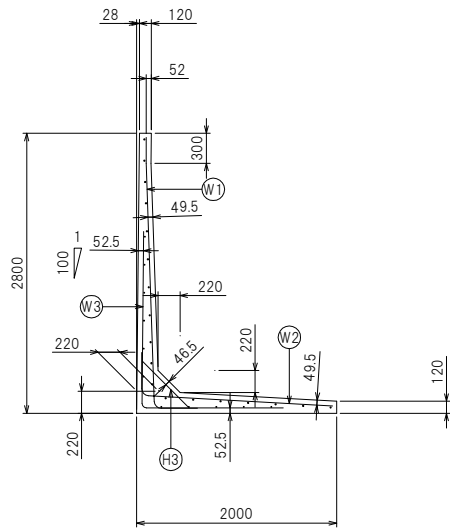

たて壁配筋図

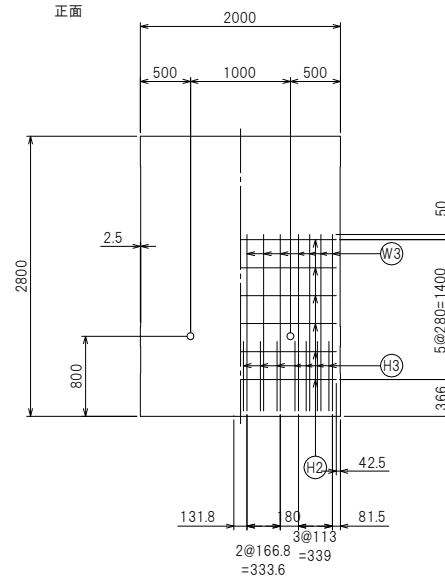

鉄筋加工図

Ⓜ1 D19 L=3113 n=14

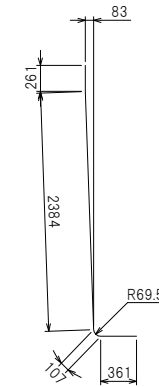

Ⓜ2 D19 L=2313 n=14

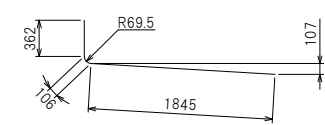

Ⓜ3 D13 L=3158 n=14

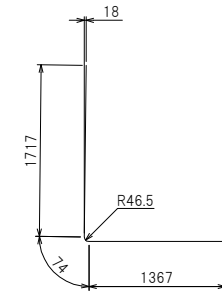

Ⓜ4 D19 L=320 n=6



Ⓜ1 D13 L=1915 n=18

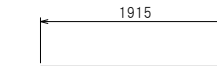

Ⓜ3 D13 L=1110 n=14

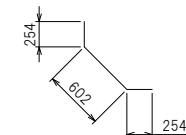

Ⓜ2 D10 L=1915 n=11

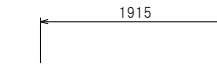

底板配筋図

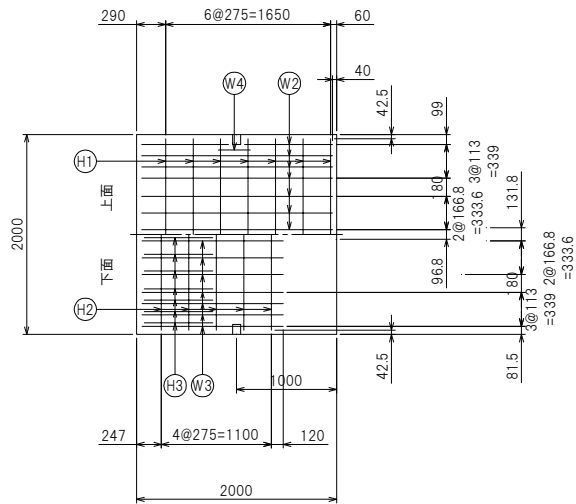

たて壁配筋図

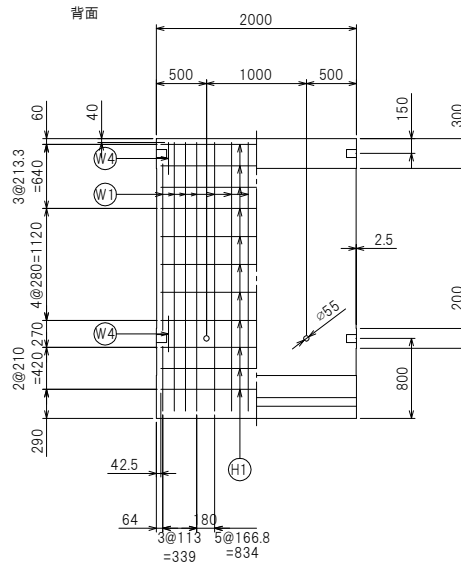

製品名	FLウォール
サイズ	2800×2000
参考重量	3830 kg
栗本建材株式会社 クリモコンクリート	