

断面配筋図

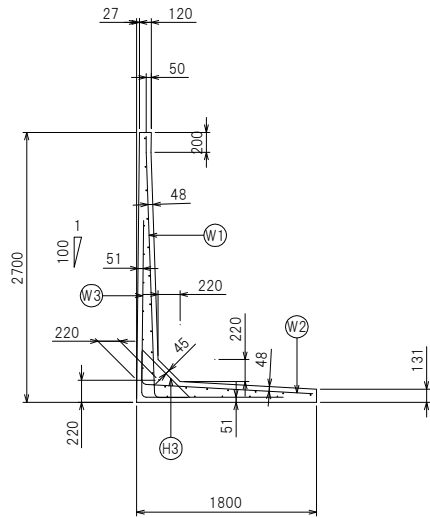

たて壁配筋図

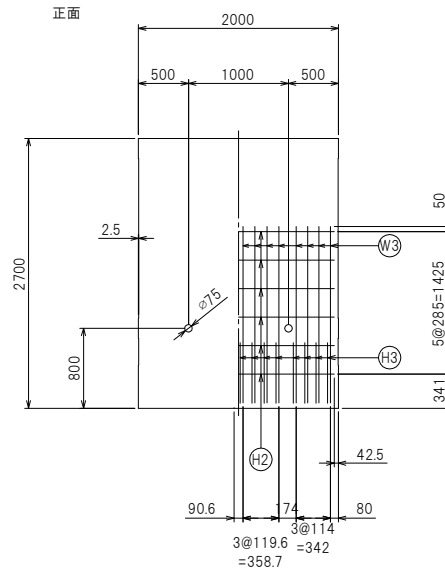

鉄筋加工図

Ⓜ1 D16 L=2923 n=16

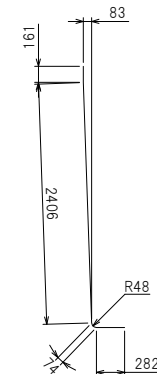

Ⓜ2 D16 L=2023 n=16

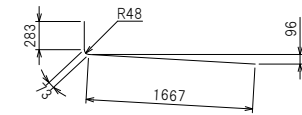

Ⓜ3 D10 L=3161 n=16

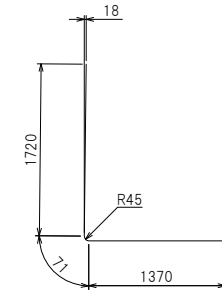

Ⓜ4 D16 L=325 n=6



Ⓜ1 D10 L=1915 n=17

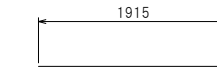

Ⓜ3 D10 L=929 n=16

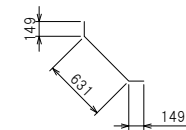

Ⓜ2 D6 L=1915 n=11

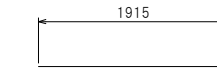

底板配筋図

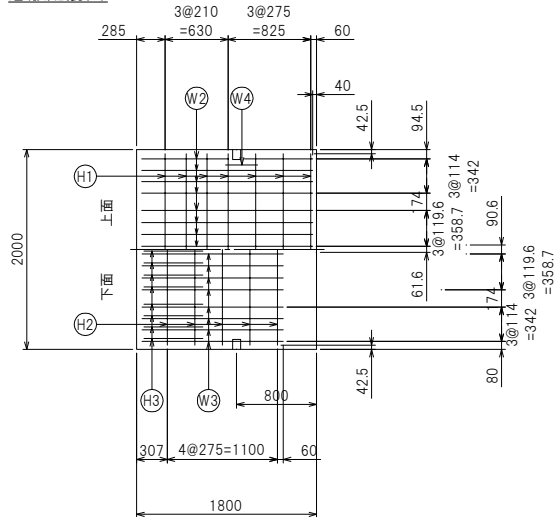

たて壁配筋図

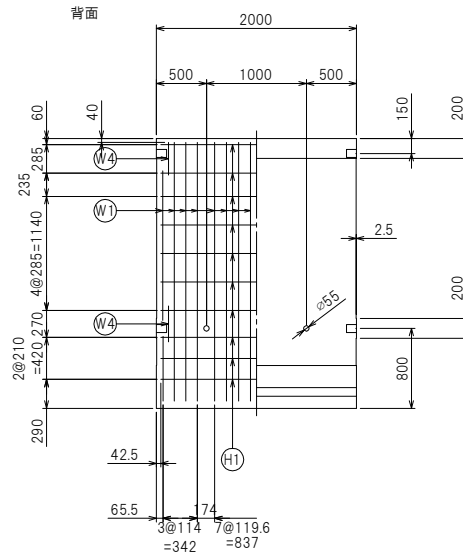

製品名	FLウォール
サイズ	2700×2000
参考重量	3654 kg
栗本建材株式会社 クリモコンクリート	