

断面配筋図

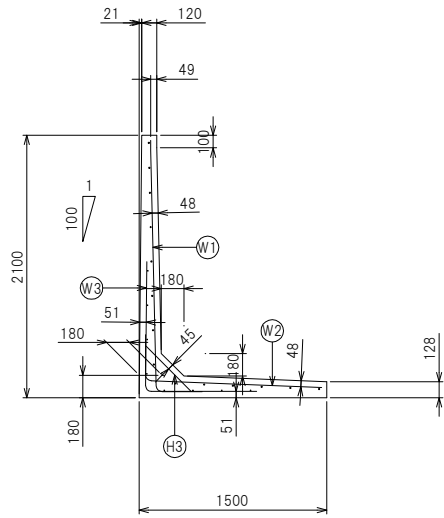

たて壁配筋図

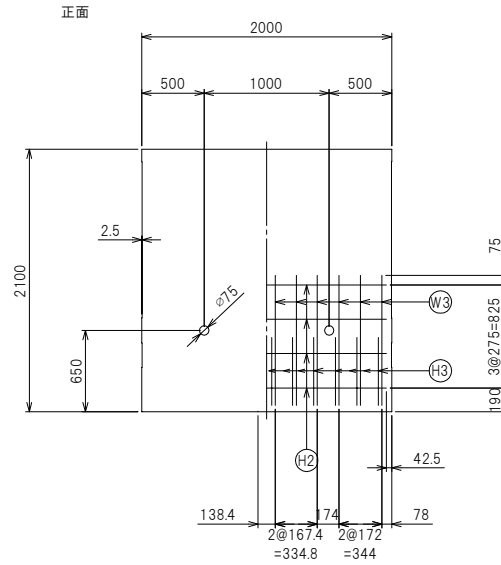

鉄筋加工図

Ⓜ1 D16 L=2361 n=12

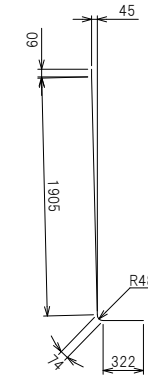

Ⓜ2 D16 L=1761 n=12

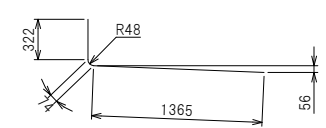

Ⓜ3 D10 L=1908 n=12

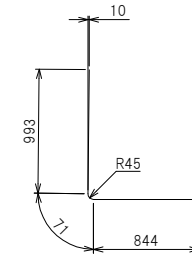

Ⓜ4 D16 L=315 n=6



Ⓜ1 D10 L=1915 n=14

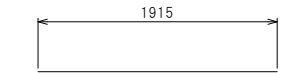

Ⓜ2 D6 L=1915 n=8

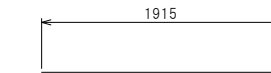

Ⓜ3 D10 L=865 n=12

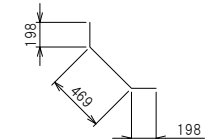

底板配筋図

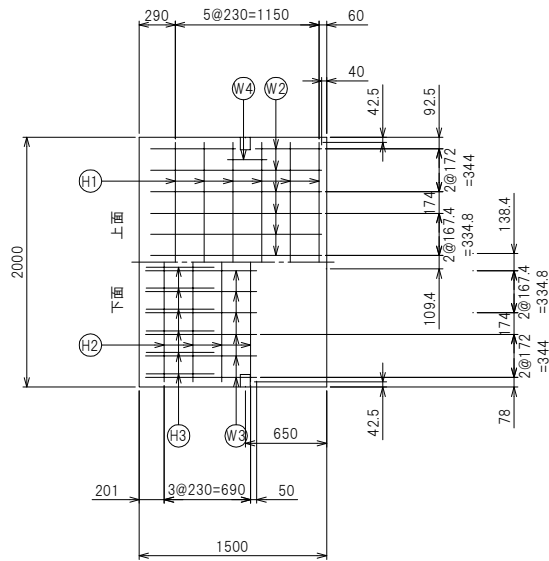

たて壁配筋図

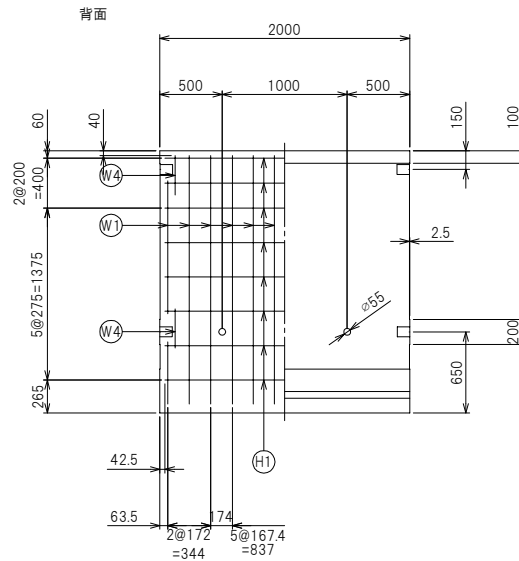

製品名	FLウォール
サイズ	2100×2000
参考重量	2567 kg
栗本建材株式会社 クリモコンクリート	